

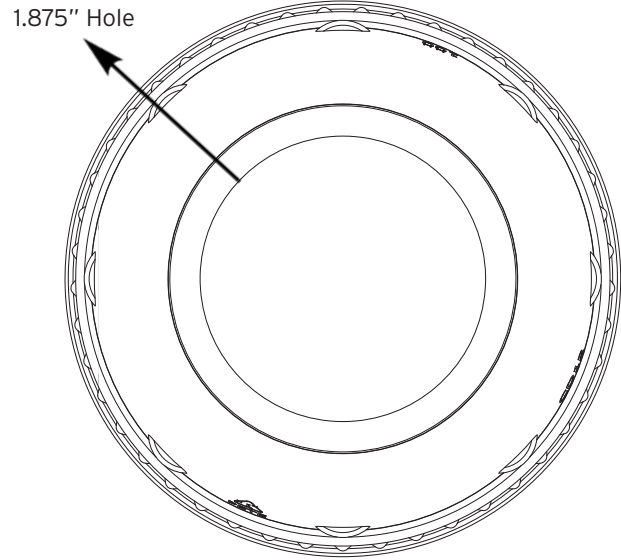

CD32 Clear High Dome

CD32N (No Hole), CD32H (Hole)

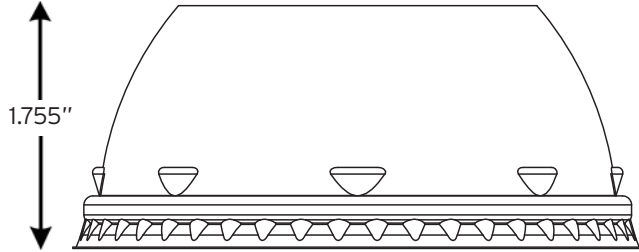

Top View

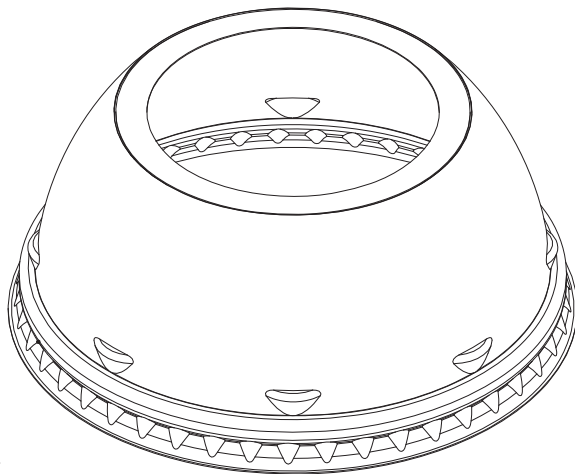

Side View

CD32 Clear High Dome Specifications

Theoretical Trim Diameter (Inches)	4.300
Theoretical Contour I.D. (Inches)	4.096
Theoretical Restriction I.D. (Inches)	4.046
Theoretical Lid Height (Inches)	1.755
Optional Center Hole I.D. (Inches)	1.875

±0.010